

Article number: 2310431011S

Description: E+G Levelling elements
LX.25-SW13-M8X19-S

Measures

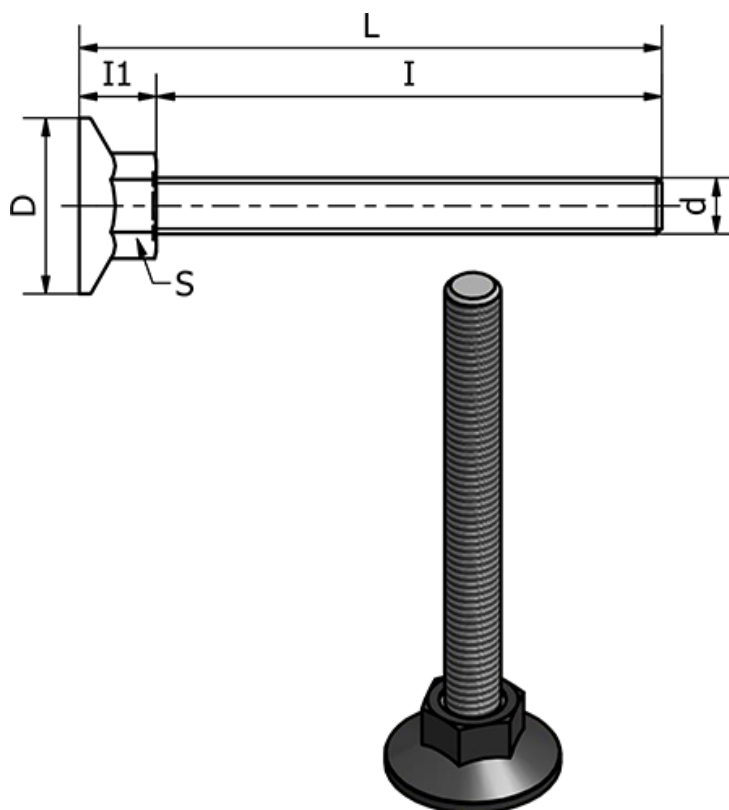

d	= M8
D	= 25
I	= 19
I1	= 11
L	= 30
S	= 13
Static load in (N)	= 2500
Type	= Forzinket

Weight (g) = -